



COMPOSING 3-D SHAPES

Name _____

Score _____

CD:20

Color the 3-D shapes used in each question.

1)

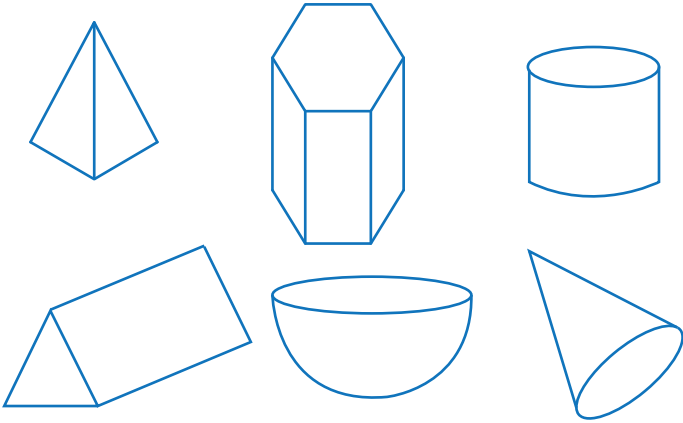
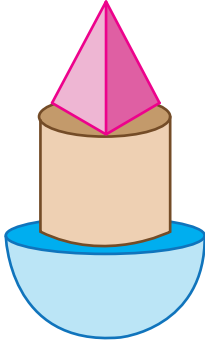

2)

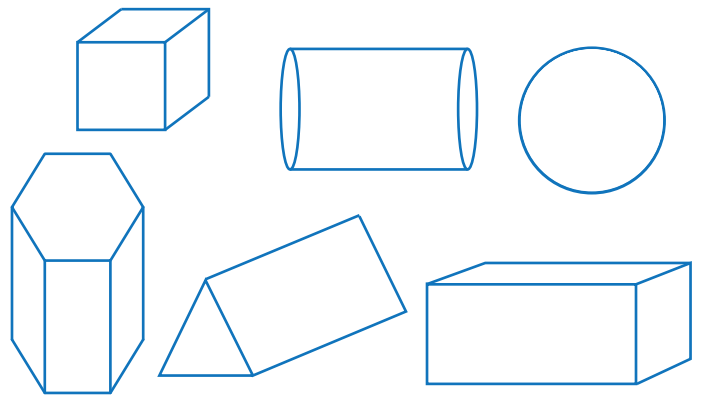
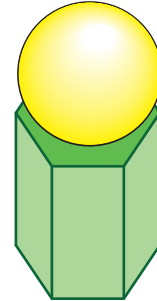

3)

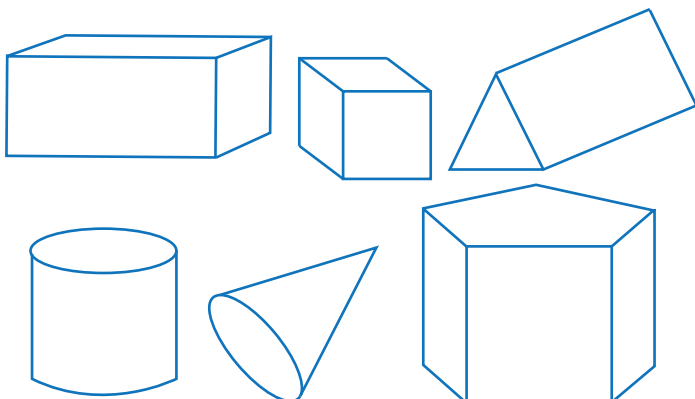
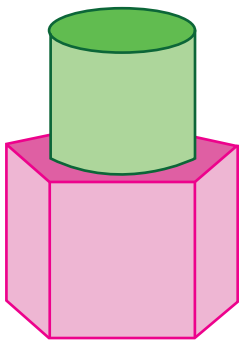

4)

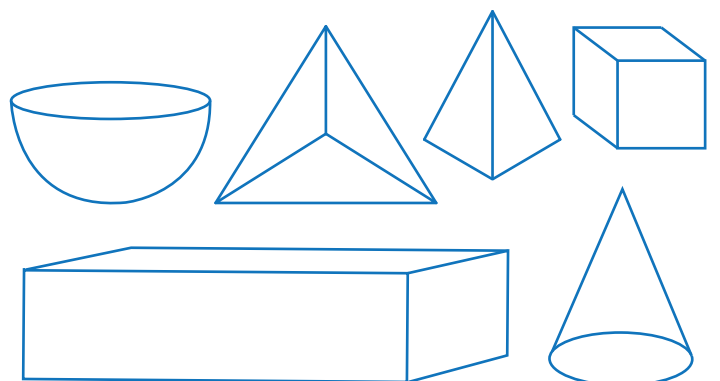
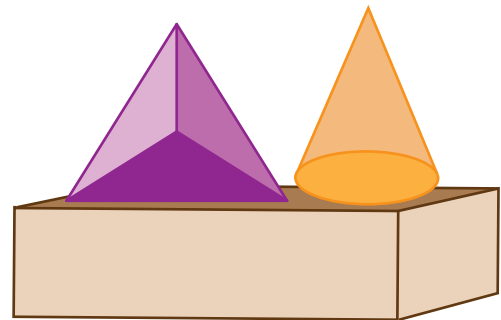



COMPOSING 3-D SHAPES

Name _____

Score _____

Answer key

CD:20

Color the 3-D shapes used in each question.

1)

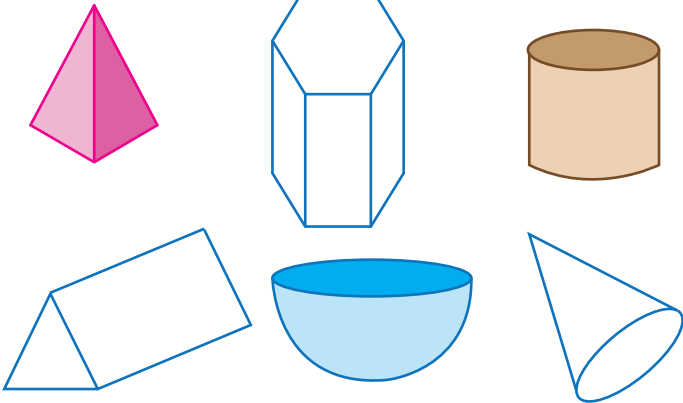
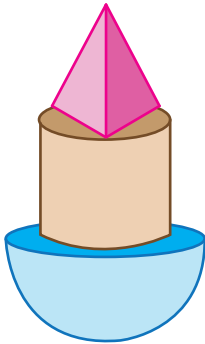

2)

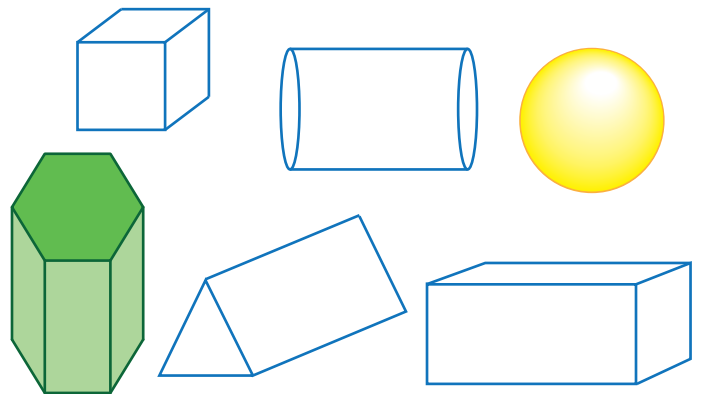
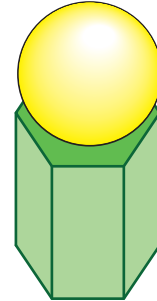

3)

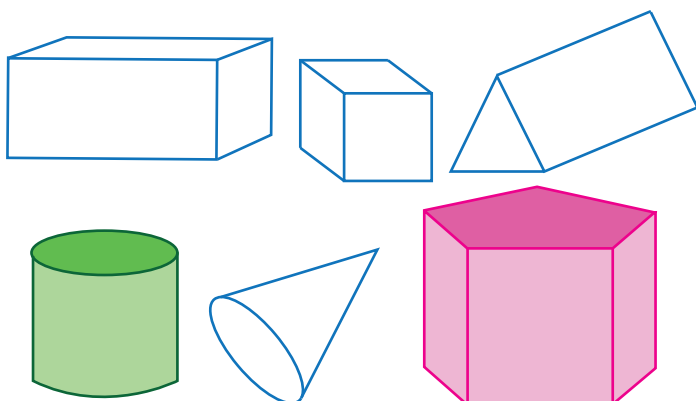
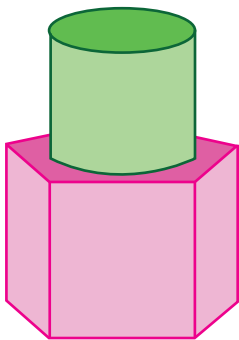

4)

